

KOMATSU®

D51EX-24 **D51PX-24** *Tier 4 Final Engine*

CRAWLER DOZER

D51



Photos may include optional equipment.

NET HORSEPOWER

131 HP @ 2200 rpm
98 kW @ 2200 rpm

OPERATING WEIGHT

D51EX-24: 30,821 lb 13980 kg
D51PX-24: 31,438 lb 14260 kg

BLADE CAPACITY

Power Angle Tilt (PAT) Dozer:
D51EX-24: 3.5 yd³ 2.7 m³
D51PX-24: 4.4 yd³ 3.4 m³

WALK-AROUND

D51EX/PX-24



Photos may include optional equipment.

NET HORSEPOWER

131 HP @ 2200 rpm
98 kW @ 2200 rpm

OPERATING WEIGHT

D51EX-24: 30,821 lb 13980 kg
D51PX-24: 31,438 lb 14260 kg

BLADE CAPACITY

Power Angle Tilt (PAT) Dozer:
D51EX-24: 3.5 yd³ 2.7 m³
D51PX-24: 4.4 yd³ 3.4 m³



INCREASED VERSATILITY & FUEL ECONOMY

Increased versatility with the option of an EX or PX undercarriage and the new high-capacity Power Angle Tilt (PAT) dozer blade.

Precise engine and efficient hydrostatic pump control technology improves operational efficiency and lowers fuel consumption.



Photos may include optional equipment.

SAA4D107E-3 EPA Tier 4 Final emissions certified engine has a water cooled variable geometry turbocharged and aftercooled 4.5 liter diesel engine which provides up to 13% increased fuel efficiency.

Komatsu Diesel Oxidation Catalyst (KDOC) and Selective Catalytic Reduction (SCR) systems reduce particulate matter and NOx using passive regeneration 100% of the time without a Komatsu Diesel Particulate Filter (KDPF). No active or manual regeneration is required.

New Komatsu Auto Idle Shutdown helps reduce nonproductive engine idle time and reduces operating costs.

New rear view monitoring system (standard) is integrated into the monitor panel and can be auto synced to reverse travel for improved operator awareness.

Advanced diagnostic system continuously monitors machine operation and vital systems to identify machine issues, assists with troubleshooting, and minimizes down time.

New single pedal can be programmed to function as either a brake or decelerator.

Efficient Cooling System:

- Electronically controlled, hydraulically-driven fan can be easily reversed through the monitor
- Rear hinged radiator guard with gas assisted lift cylinders opens easily for cleaning
- Side-by-side single plane coolers help reduce chances of plugging and simplify maintenance

KOMTRAX® 5.0 telematics sends information to a secure website, including machine location, SMR, error codes, cautions, maintenance items, fuel usage, fuel levels, DEF levels, ambient conditions, operator identification, and much more.

New Operator Identification System (standard) provides KOMTRAX data for machine operation and applications for up to 100 individual ID codes.

Integrated ROPS cab features:

- Large, quiet, pressurized cab meets ISO 3471 standard
- Exceptional visibility with super slant nose design and integrated ROPS structure
- Heated air-suspension seat (standard)
- Standard aux jack, (2) 12V power convertors, and 24V cigarette lighter

Improved durability:

- Heavy-plate steel used for the nose and the hydraulic and fuel tanks
- Dozer frame with steel castings
- Komatsu designed and manufactured components
- New high wear-resistant dozer moldboard

Self-adjusting idler support provides constant and even idler tension, reducing vibration and increasing undercarriage life.

Standard Parallel Link Undercarriage System (PLUS) provides up to double the wear life and lowers repair and maintenance costs compared to a standard undercarriage design.

New Triple Labyrinth Final Drive Shield design provides additional protection for the final drive floating seals.

New Power Angle Tilt (PAT) dozer with manually adjustable blade pitch increases productivity in a variety of applications.

New D51PX-24 PAT high-capacity (4.4 yd³), high-wear resistant blade can increase production up to 15%.

Complete operator blade control:

- Palm Command Control System (PCCS)
- Electronic Proportional Control (EPC)
- Blade angle switch
- New three blade control settings (fine, normal, fast)
- New up to 5 individual operator settings can be stored

Efficient Hydrostatic Transmission with electronic control:

- Customizable quick shift (3 speed) settings for the operator
- Variable speed selection (20 speeds)
- HST control system helps reduce fuel consumption and improves maneuverability

New large color monitor:

- Easy-to-read and use large 7" high-resolution multi-color LCD monitor
- Ecology guidance
- Easy-to-use onboard diagnostics that don't require a laptop
- Real-time DEF monitoring so the operator can see actual DEF levels
- Five customizable operator settings for machine control
- Integrated rearview camera

New convenient shovel holder (standard)

PERFORMANCE FEATURES

KOMATSU NEW ENGINE TECHNOLOGIES

Komatsu's New Emission Regulations-compliant Engine

New regulations effective in 2014 require the reduction of NOx emissions. In addition to refining the U.S. EPA Tier 4 Interim technologies, Komatsu developed a new Selective Catalytic Reduction (SCR) device in-house.

- ① Komatsu Diesel Oxidation Catalyst (KDOC)
- ② Water-cooled variable geometry turbocharger
- ③ Komatsu Closed Crankcase Ventilation (KCCV)
- ④ SCR

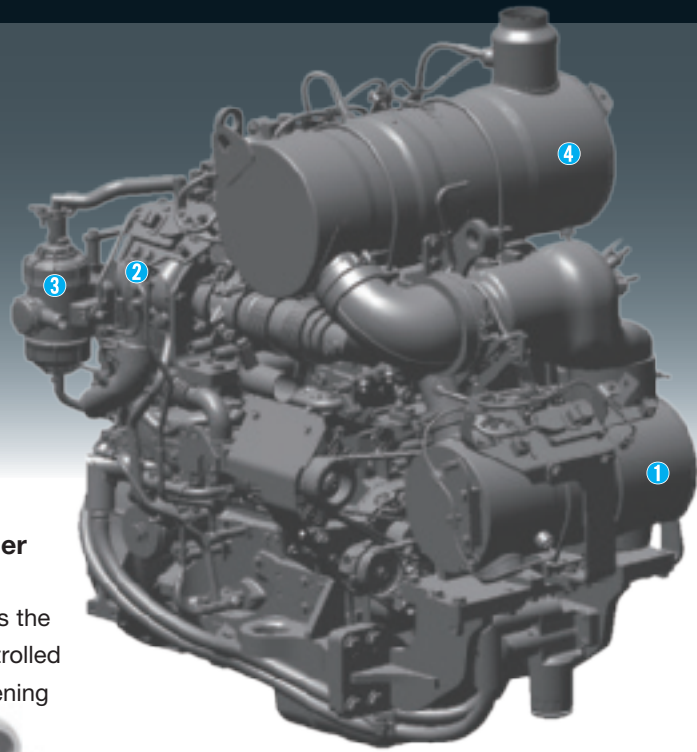

Technologies Applied to New Engine

Water cooled variable geometry turbocharger

A newly designed variable geometry turbocharger features simple and reliable technology that controls the intake air-flow. Exhaust turbine wheel speed is controlled by the nozzle ring which varies the exhaust gas opening to provide the optimal volume of air to the engine combustion chamber under all speed and load conditions. The result is cleaner exhaust gas while maintaining power and performance.

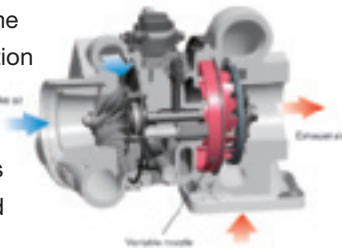

Cooled Exhaust Gas Recirculation (EGR)

Cooled EGR, a technology well-proven in existing Komatsu engines, reduces NOx emissions. These components ensure reliable performance during the demanding work conditions of construction equipment.

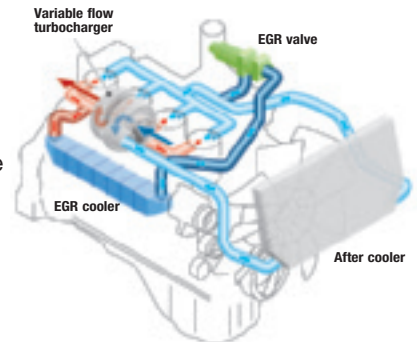

Heavy-duty aftertreatment system

This new system consists of a KDOC and a SCR. The SCR NOx reduction system injects the correct amount of Diesel Exhaust Fluid (DEF) at the proper rate, thereby decomposing NOx into non-toxic water (H₂O) and nitrogen gas (N₂).

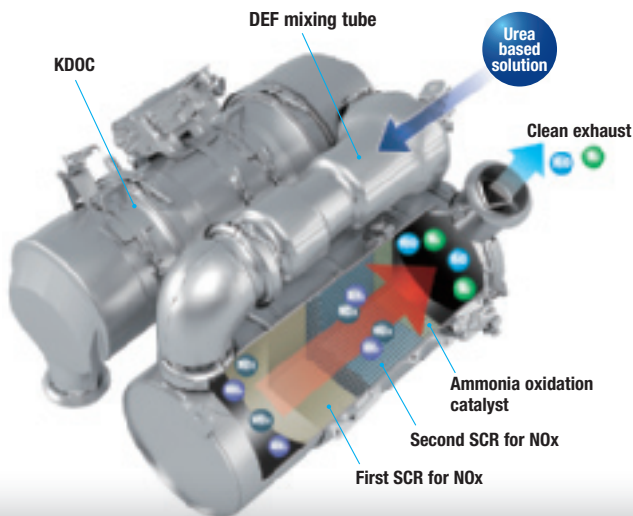

Komatsu Closed Crankcase Ventilation (KCCV)

Crankcase emissions (Blowby gas) are passed through a KCCV filter. The KCCV filter traps oil mist which is returned back to the crankcase while the gas, which is almost oil mist free, is fed back to the air intake.



D51EX/PX-24

Heavy-duty High Pressure Common Rail (HPCR) fuel injection system

The system is designed to achieve an optimal injection of high-pressure fuel by means of computerized control, thereby bringing close to complete combustion to reduce Particulate Matter (PM) emissions. While this technology is already used in current engines, the new system uses higher-pressure fuel injection, thereby reducing both PM emissions and fuel consumption over the entire engine power range.

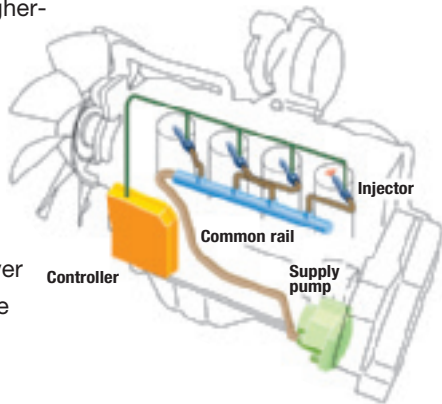

Advanced electronic control system

The electronic control system performs high-speed processing of all signals from sensors installed in the vehicle and engine. This ensures total control of the equipment under all conditions. Engine condition information is displayed via an on-board network on the monitor inside the cab. Furthermore, KOMTRAX helps customers use this information to keep up with maintenance needs.

Redesigned combustion chamber at top of piston

The combustion chamber at the top of the piston has a new shape designed to improve combustion and further reduce NOx, PM, fuel consumption and noise.

Auto Idle Shutdown Function

Komatsu auto idle shutdown automatically shuts the engine down after idling for a set period of time to reduce unnecessary fuel consumption and exhaust emissions. The amount of time before the engine is shutdown can be easily programmed from 5 to 60 minutes.



PRODUCTIVITY & FUEL ECONOMY FEATURES

HYDROSTATIC TRANSMISSION (HST) CONTROL SYSTEM

HST Control System

The HST controller monitors engine output and work load. It controls HST pump and motor displacement to provide the optimum speed and drawbar pull. Full power to both tracks during turns or counter-rotation makes the D51EX/PX-24 extremely maneuverable.



Fuel Efficiency

The efficient electronically controlled HST system can reduce fuel consumption.

Fuel consumption reduced by up to 13%

Compared with D51EX/PX-22 in P mode
Based on typical work pattern collected via KOMTRAX

Hydraulically Driven Cooling Fan

The engine cooling fan's speed is electronically controlled. Fan speed depends on engine coolant and oil temperatures. The fan will only rotate as fast as is necessary to adequately cool the machine's fluid. This system increases fuel efficiency, reduces operating noise levels and requires less horsepower than a belt-driven fan.

Long Track-On-Ground and Oscillating Track Frame

Long machine track-on-ground and oscillating track frames improve stability and grading/dozing performance.

Selectable Working Mode

P mode is the mode designed for powerful operation and maximum production. E mode is designed for general dozing applications, providing adequate speed and power, while saving energy. For fuel reduction and energy savings, the monitor panel allows the operator to easily switch between working modes, depending on working conditions.

P mode (Power mode)

With P mode, the engine outputs its full power, allowing the machine to perform work requiring large production, heavy-load, and uphill work.

E mode (Economy mode)

With E mode, the engine outputs enough power for the work without delivering unnecessary power. This mode enables energy saving operation and is ideal on hard or rough surfaces that often cause shoe slip and work not requiring as much power, such as downhill dozing, leveling and light-load work.

PAT DOZER

Moldboard PAT Dozer with Adjustable Pitch

A high wear-resistant power angle, power tilt dozer blade with adjustable blade pitch is available on the D51EX/PX-24. The hydraulic blade tilt and angling function expands versatility and productivity in a variety of applications.



High Productivity

The D51PX PAT high-capacity (4.4 yd³), high wear-resistant blade can increase production.

Production increased by up to **15%**



Unrivalled Blade Visibility

The D51EX/PX-24 incorporates Komatsu's super-slant nose design. Komatsu's innovative design provides excellent blade visibility for improved machine control and increased efficiency and productivity.



CONTROL FEATURES



Palm Command Control System (PCCS) Levers

Komatsu's ergonomically designed PCCS handles create an operating environment with complete operator control.

PCCS

The low-effort PCCS joystick controls all directional movements, including machine travel speed as well as counter-rotation.

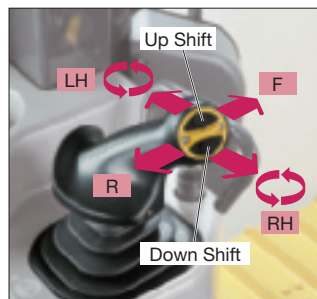

Electronic controlled hydraulic system

Electronic controlled palm commanded joystick provides precise blade control. New blade angling switch operation provides easier and predictable blade control.

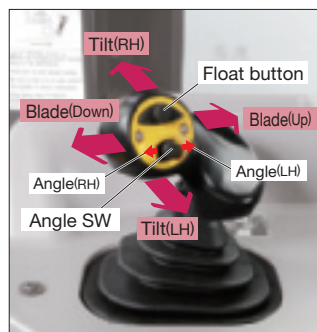

HST with Electronic Control

The D51EX/PX-24 is equipped with Komatsu-designed HST that allows for Quick-Shift or variable speed selection. The HST consists of dual-path closed-circuits, with two variable displacement piston pumps and two variable displacement travel motors. Hydrostatic steering eliminates steering clutches and brakes, providing smooth, powerful turns. Fully electronic control provides complete automatic shifting and enables smooth control. Engine speed is controlled using an electronic fuel control dial.

One-Pedal Design (Decelerator/Brake Pedal) Controls Speed, During Operation

Machine operation is simple because brake function has been integrated into the decelerator pedal. Machine travel speed can be controlled using one pedal. The pedal function can be changed by a mode selector switch.



Decelerator mode: The pedal modulates engine rpms and vehicle travel speed. It can be used for all applications.
Brake mode: The pedal modulates vehicle travel speed while maintaining high-engine speed. This mode can be helpful to maintain work-equipment speed, while using the brake function.

WORKING ENVIRONMENT

Integrated ROPS Cab

The D51EX/PX-24 cab meets: ROPS standard ISO 3471:2008 FOPS Level 2 standard ISO 3449:2005 High rigidity and superb sealing reduces noise and vibration for the operator. The pressurized, climate controlled cab helps provide the operator with a fresh and clean working environment. Also, operators enjoy more side visibility because additional external ROPS posts are not required.



Comfortable Ride with Cab Damper Mounting

The D51EX/PX-24's cab mount uses a cab damper system that provides excellent shock and vibration absorption which conventional mounting systems are unable to match. The silicon-oil-filled cab damper mount helps to isolate the cab from the machine body, suppressing vibration and providing a quiet, comfortable operating environment.

Auxiliary Input Jack & Two DC12 Volt Electrical Outlets

By connecting an auxiliary device to this plug input, the operator can play audio from a mobile device through the machine's sound system. Two DC12 volt electrical outlets can be used as a power source for radio equipment or others. One DC 24 volt cigarette lighter.

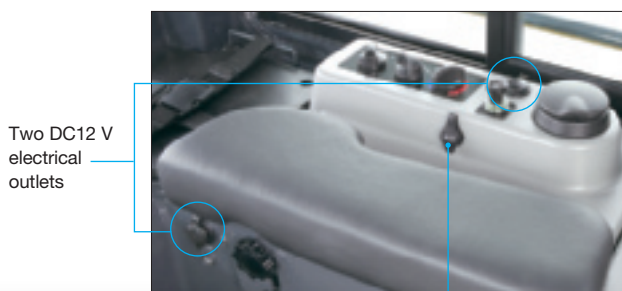

Two DC12 V electrical outlets

Auxiliary input jack

Comfortable Ride with Heated Operator Seat

The operator seat has adjustable lumbar support, tilt and an electric heater. It is easy to adjust to the operator's shape and comfortable operation is possible in a variety of conditions. Also, the seat heat makes it possible to work comfortably in the winter.



ADDITIONAL OPERATOR CONVENIENCE EQUIPMENT

Rear view monitor system

On the large LCD color monitor, the operator can view, through one camera, areas directly behind the machine. This camera can be synchronized with reverse operation.



Secondary engine shutdown switch

A new secondary switch has been added at the side of the front console to shut down the engine in an emergency.



RELIABILITY & MAINTENANCE FEATURES

Excellent Reliability & Durability

Parallel Link Undercarriage System (PLUS)

Komatsu's PLUS rotating bush design provides less downtime, longer wear, and with up to 40% lower undercarriage maintenance costs, than conventional undercarriage. Rotating bushings eliminate the cost and downtime for bushing turns, and strengthened rollers and links increase wear life up to two times. With PLUS, individual links can be replaced with common track tools.

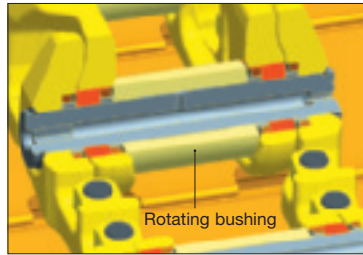

Modular design

One of the design goals behind the creation of the D51EX/PX-24 was to manufacture a more durable machine. This was achieved by reducing component complexity and using a strong modular design for increased serviceability and durability.



Self-adjusting idler support

The self-adjusting idler support provides constant and even tension on idler guide plates, reducing noise and vibration and increasing undercarriage life.

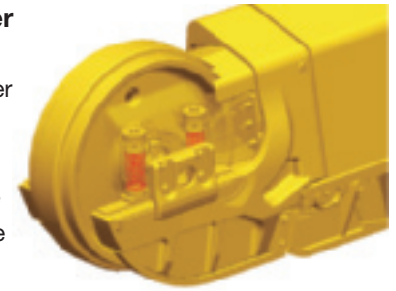

Easy Maintenance

Planned maintenance and daily checks are the only way to ensure long service life from equipment. That's why Komatsu designed the D51EX/PX-24 with conveniently located maintenance points to make necessary inspections and maintenance quick and easy.

Rear, hydraulically-driven, swing-up fan

The D51EX/PX-24 utilizes a swing-up fan with a gas strut-assisted lift system to provide easy access to the (side-by-side) radiator, oil cooler and charge air cooler. The hydraulic fan is reversible to help keep the radiator cores clean and simplify maintenance.



TECHNOLOGY FEATURES

Large Multi-Lingual High Resolution LCD Monitor

A large, user-friendly color monitor provides easy-to-understand information for the operator. Excellent screen visibility is achieved with a high resolution LCD monitor that is easy to read at various angles and lighting conditions. Simple and easy-to-operate switches and function keys facilitate multi-function operations. The monitor displays data in 26 languages.

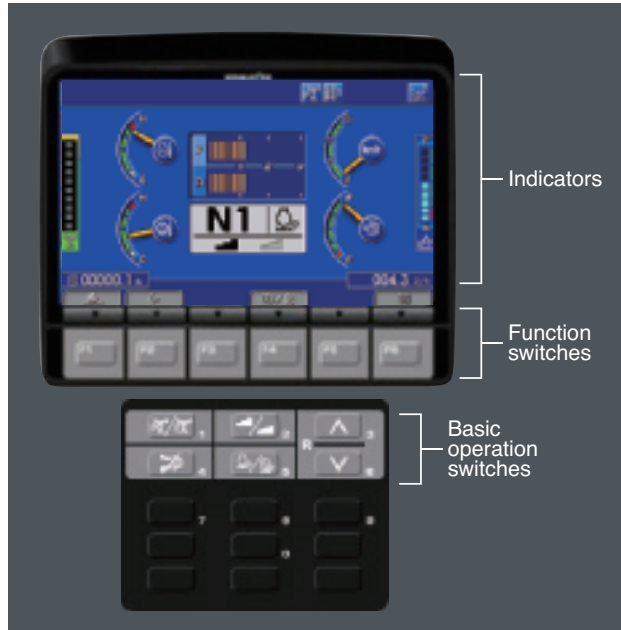

Multi-monitor with Troubleshooting Function to Minimize Down Time

Various meters, gauges and warning functions are centrally arranged on the multi-monitor. The monitor simplifies start-up inspection and promptly warns the operator with a lamp and buzzer if any abnormalities occur. In addition, warning indicators are displayed in 4 levels to alert the operator of potential issues. Replacement times for required PM services are also indicated.



Energy Saving Operation

Ecology guidance

In order to support efficient operation, the following four messages are displayed for fuel saving operation. These can be displayed by the operator, if desired.

- 1) Avoid Excessive Engine Idling
- 2) Use Economy Mode to Save Fuel
- 3) Avoid Hydraulic Relief Pressure
- 4) Avoid Over Load

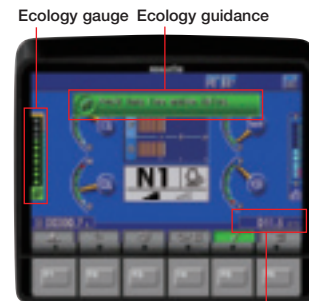

Fuel consumption display

Ecology gauge

To help the operator to perform in an environmentally friendly way and minimize energy consumption, an easy-to-read “Ecology gauge” is displayed on the left of the multi-monitor screen.

Fuel consumption display

Average fuel consumption during the day is displayed and updated every 10 seconds.

KOMTRAX Web Based Reports

KOMTRAX is Komatsu’s remote equipment and fleet monitoring system. Wireless technology and a secure web-based application communicate the information needed to make the best possible operation and management decisions. From location, actual hours worked and fuel consumption, to maintenance monitoring, abnormality codes and load frequency, operators receive reports that are simple to read and understand. The new D51EX/PX-24 adds the following new information for fuel consumption reduction.

- Guidance to improve fuel consumption
- Operating hours by operation mode (E or P mode)
- Service information for U.S. EPA Tier 4 Final emissions system

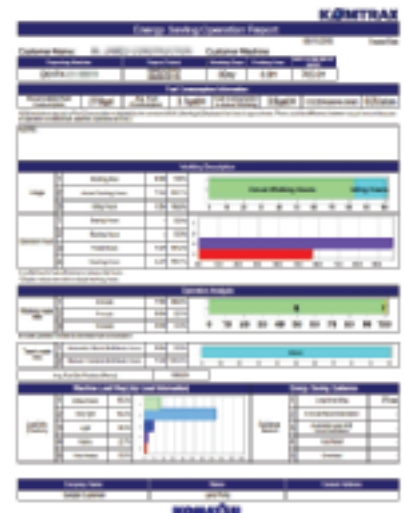

KOMATSU PARTS & SERVICE SUPPORT



KOMATSU CARE®

Program Includes:

*The D51EX/PX-24 comes standard with complimentary factory scheduled maintenance for the first 3 years or 2,000 hours, whichever comes first.

Planned Maintenance Intervals at:

500/1000/1500/2000 hour intervals. (250 hr. initial interval for some products) Complimentary Maintenance Interval includes: Replacement of Oils & Fluid Filters with genuine Komatsu Parts, 50-Point inspection, Komatsu Oil & Wear Analysis Sampling (KOWA) / Travel & Mileage (distance set by distributor; additional charges may apply).

Benefits of Using Komatsu CARE

- Assurance of Proper Maintenance with OEM Parts & Service
- Increased Uptime & Efficiency
- Factory Certified Technicians Performing Work
- Cost of Ownership Savings
- Transferable Upon Resale

Complimentary SCR System Maintenance

The D51EX-24 also includes 2 factory recommended services of the Selective Catalytic Reduction (SCR) Diesel exhaust fluid (DEF) system during the first 5 years—including:

- Factory recommended DEF tank flush and strainer cleaning at 4,500 hours and 9,000 hours

Komatsu CARE® – Advantage Extended Coverage

- Extended Coverage can provide peace of mind by protecting customers from unplanned expenses that effect cash flow
- Purchasing extended coverage locks-in the cost of covered parts and labor for the coverage period and helps turn these into fixed costs



Komatsu Parts Support

- 24/7/365 to fulfill your parts needs
- 9 parts Distribution Centers strategically located across the U.S. and Canada
- Distributor network of more than 300 locations across U.S. and Canada to serve you
- Online part ordering through Komatsu eParts
- Remanufactured components with same-as-new warranties at a significant cost reduction



Komatsu Oil and Wear Analysis (KOWA)

- KOWA detects fuel dilution, coolant leaks, and measures wear metals
- Proactively maintain your equipment
- Maximize availability and performance
- Can identify potential problems before they lead to major repairs
- Reduce life cycle cost by extending component life

KOMATSU CARE D51EX/PX-24

Interval PM	500	1000	1500	2000
KOWA SAMPLING – (Engine, Hydraulics, L & R Final Drives)	✓	✓	✓	✓
LUBRICATE MACHINE, INCLUDING EQUALIZER BAR CENTER AND SIDE PINS	✓	✓	✓	✓
CHANGE ENGINE OIL	✓	✓	✓	✓
REPLACE ENGINE OIL FILTER	✓	✓	✓	✓
REPLACE FUEL PRE-FILTER	✓	✓	✓	✓
REPLACE A/C FRESH & RECIRCULATION FILTERS	✓	✓	✓	✓
DRAIN SEDIMENT FROM FUEL TANK	✓	✓	✓	✓
CLEAN AIR CLEANER ELEMENT	✓	✓	✓	✓
COMPLETE 50 POINT INSPECTION FORM; LEAVE PINK COPY WITH CUSTOMER OR IN CAB	✓	✓	✓	✓
RESET MONITOR PANEL MAINTENANCE COUNTER FOR APPROPRIATE ITEMS	✓	✓	✓	✓
REPLACE FUEL MAIN FILTER		✓		✓
REPLACE FUEL TANK BREATHER ELEMENT		✓		✓
REPLACE DEF TANK BREATHER ELEMENT		✓		✓
REPLACE HYDRAULIC TANK BREATHER ELEMENT		✓		✓
CHANGE FINAL DRIVE OIL		✓		✓
CHANGE HYDRAULIC OIL				✓
REPLACE HYDRAULIC FILTER				✓
REPLACE HST FILTER				✓
REPLACE KCCV FILTER				✓
CLEAN HYDRAULIC TANK STRAINER				✓
REPLACE DEF PUMP FILTER				✓
FACTORY TRAINED TECHNICIAN LABOR	✓	✓	✓	✓
2 SCR System Maintenance Services at 4,500 Hrs. and 9,000 Hrs.				

* Certain exclusions and limitations apply. Refer to the customer certificate for complete program details and eligibility. Komatsu® and Komatsu Care® are registered trademarks of Komatsu Ltd. Copyright 2018 Komatsu America Corp.

D51EX/PX-24

KOMTRAX EQUIPMENT MONITORING

GET THE WHOLE STORY WITH
KOMTRAX[®]

✓ WHAT

- KOMTRAX is Komatsu's remote equipment monitoring and management system
- KOMTRAX **continuously monitors and records** machine health and operational data
- Information such as fuel consumption, utilization, and a detailed history **lowering owning and operating cost**

✓ WHO

- KOMTRAX is **standard** equipment on all Komatsu construction products

✓ WHEN

- Know when your machines are **running or idling** and make decisions that will improve your fleet utilization
- Detailed movement records ensure you know when and where your equipment is moved
- Up to date records allow you to **know when maintenance is due** and help you plan for future maintenance needs

✓ WHERE

- KOMTRAX data **can be accessed virtually anywhere** through your computer, the web or your smart phone
- Automatic alerts keep fleet managers up to date on the latest machine notifications

✓ WHY

- Knowledge is power - **make informed decisions** to manage your fleet better
- Knowing your idle time and fuel consumption will help maximize your machine efficiency
- **Take control of your equipment** - any time, anywhere



KOMTRAX[®]

For construction and compact equipment.

KOMTRAX Plus[®]

For production and mining class machines.

SPECIFICATIONS



ENGINE

Model..... Komatsu SAA4D107E-3*
 Type 4-cycle, water-cooled, direct injection
 Aspiration..... Variable geometry, water-cooled, turbocharged, air-to-air aftercooled
 Number of cylinders..... 4
 Bore x stroke..... 107 mm x 124 mm **4.21" x 4.88"**
 Piston displacement..... 4.5 ltr **275 in³**
 Governor..... All-speed, electronic
 Horsepower
 SAE J1995.....Gross 99 kW **133 HP**
 ISO 9249 / SAE J1349.....Net 98 kW **131 HP**
 Hydraulic fan at maximum speed.....Net 91 kW **122 HP**
 Rated rpm.....2200 rpm
 Fan drive type.....Hydraulic
 Lubrication system
 Method.....Gear pump, force lubrication
 Filter..... Full-flow

*EPA Tier 4 Final emissions certified



HYDROSTATIC TRANSMISSION

Dual-path, hydrostatic transmission provides infinite speed changes up to 9.0 km/h **5.6 mph**. The variable capacity travel motors allow the operator to select the optimum speed to match specific jobs. Travel control lock lever and neutral switch.

Travel speed (quick shift mode)*	Forward	Reverse
1st	0-3.4 km/h 0-2.1 mph	0-4.1 km/h 0-2.5 mph
2nd	0-5.6 km/h 0-3.5 mph	0-6.5 km/h 0-4.0 mph
3rd	0-9.0 km/h 0-5.6 mph	0-9.0 km/h 0-5.6 mph

Travel speed (variable mode)	Forward	Reverse
	0-9.0 km/h 0-5.6 mph	0-9.0 km/h 0-5.6 mph

*Quick shift speeds are adjustable in the monitor.

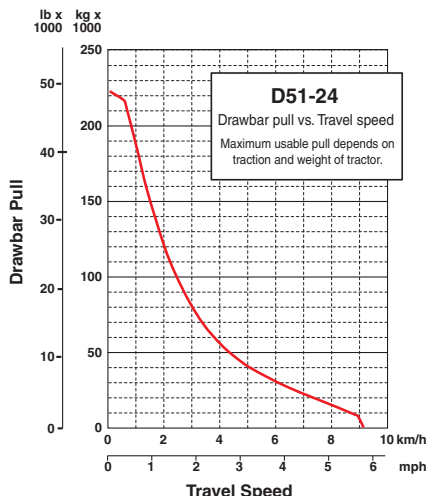

Note: The maximum usable pull depends on traction and weight of tractor including mounted equipment.



FINAL DRIVES

In-shoe mounted, axial-piston-type travel motors, with integrated two-stage planetary gear reduction. Compact, in-shoe mount reduces risk of damage by debris. Bolt-on sprocket ring with triple labyrinth seal design.



STEERING SYSTEM

Palm Command Control System (PCCS) joystick control for all directional movements. Pushing the joystick forward results in forward machine travel, while pulling it back reverses the machine. Simply tilt the joystick to the left or right to make a turn. Tilting the joystick fully to the left or right activates counter-rotation.

Hydrostatic Transmission (HST) provides smooth, powerful turns. Fully electronic control enables smooth control that can be adjusted in the monitor. The PCCS utilizes shift buttons to increase and decrease speed.

Minimum turning radius*

D51EX-24 2.4 m **94"**

D51PX-24 2.6 m **102"**

*As measured by track marks on the ground at pivot turn.



UNDERCARRIAGE

Suspension Rigid type
 Track roller frame Monocoque, large section, durable construction
 Rollers & idlers Lubricated track rollers

Sealed & lubricated track...Track tension easily adjusted w/grease gun

	D51EX-24	D51PX-24
Number of track rollers (each side)	7	7
Type of shoes (standard)	Single grouser	Single grouser
Number of shoes (each side)	44	44
Grouser height	mm in 55 2.2"	55 2.2"
Shoe width (standard)	mm in 560 22"	710 28"
Ground contact area (ISO 16754)	cm ² 30750	38980
	in ² 4,766	6,042
Ground pressure (with dozer, ROPS cab)	kPa 39.9	32.1
(ISO 16754)	kgf/cm ² 0.40	0.32
	psi 5.79	4.66
Track gauge	mm ft.in 1790 5'10"	1880 6'2"
Length of track on ground	mm ft.in 2745 9'0"	2745 9'0"



SERVICE REFILL CAPACITIES

Coolant 37 ltr **9.8 U.S. gal**
 Fuel tank 270 ltr **71.3 U.S. gal**
 Engine oil 16 ltr **4.2 U.S. gal**
 Hydraulic tank 64 ltr **17 U.S. gal**
 Final drive (each side)..... 5.5 ltr **1.5 U.S. gal**
 Diesel Exhaust Fluid (DEF) tank20.5 ltr **5.42 U.S. gal**



OPERATING WEIGHT (APPROXIMATE)

Tractor weight:

Including ROPS cab, U frame for Power Angle Tilt (PAT) dozer, rated capacity of lubricant, coolant, full fuel tank, operator, and standard equipment.

D51EX-24..... 12330 kg **27,182 lb**

D51PX-24..... 12550 kg **27,668 lb**

Operating weight:

Including Power Angle Tilt (PAT) dozer, ROPS cab, operator, standard equipment, rated capacity of lubricant, hydraulic control unit, coolant, and full fuel tank.

D51EX-24..... 13980 kg **30,821 lb**

D51PX-24..... 14260 kg **31,438 lb**



DIMENSIONS

	D51EX-24		D51PX-24	
A	3045 mm	10'	3350 mm	11'
B	425 mm	1'5"	470 mm	1'7"
C	1120 mm	3'8"	1170 mm	3'10"
D	1015 mm	3'4"	1035 mm	3'5"
E	455 mm	1'6"	475 mm	1'7"
F	2745 mm	9'	2745 mm	9'
G	4800 mm	15'9"	4850 mm	15'11"
H	3015 mm	9'11"	3015 mm	9'11"
I	55 mm	2.2"	55 mm	2.2"
J	1790 mm	5'10"	1880 mm	6'2"
K	560 mm	22"	710 mm	28"
L	2350 mm	7'9"	2590 mm	8'6"
M	2720 mm	8'11"	2990 mm	9'10"
N	5485 mm	18'	5605 mm	18'5"

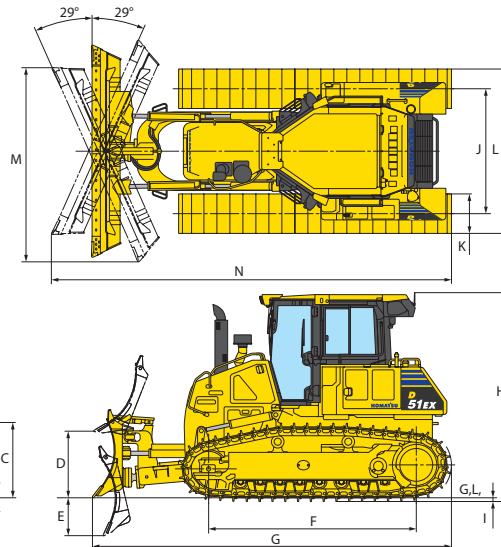
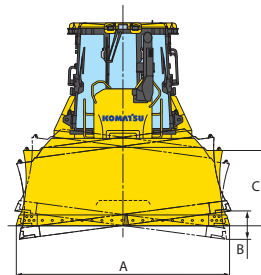

Ground clearance 390 mm **15"**



HYDRAULIC SYSTEM

Closed-Center Load Sensing System (CLSS) designed for precise and responsive control, and for efficient simultaneous operation.

Hydraulic control unit:

All spool control valves externally mounted remote to the hydraulic tank. Piston-type hydraulic pump with capacity (discharge flow) of 97 ltr/min **26 U.S. gal/min** at rated engine rpm.

Relief valve setting 27.4 MPa 280 kg/cm² **3,974 psi**
 Hydraulic cylinders Double-acting, piston type

	Number of cylinders	Bore
Blade lift	2	90 mm 3.5"
Blade tilt	1	100 mm 4"
Blade angle	2	90 mm 3.5"

Hydraulic oil capacity (refill):

Power angle tilt dozer 64 ltr **17 U.S. gal**

Control valves:

3-spool control valve for Power Angle Tilt dozer

Positions:

Blade lift Raise, hold, lower, and float
 Blade tilt Right, hold, and left
 Blade angle Right, hold, and left

Additional control valve required for ripper

Positions:

Ripper lift Raise, hold, and lower



DOZER EQUIPMENT

	Overall Length With Dozer mm ft.in	Blade Capacity m ³ yd ³	Blade Width x Height mm ft.in	Max. Lift Above Ground mm ft.in	Max. Drop Below Ground mm ft.in	Max. Tilt Adjustment mm ft.in
D51EX-24	4800	2.7	3045 x 1120*	1015	455	425
Power Angle Tilt Dozer	15'9"	3.5	10' x 3'8"	3'4"	1'6"	1'5"
D51PX-24	4850	3.4	3350 x 1170	1035	475	470
Power Angle Tilt Dozer (High-capacity)	15'11"	4.4	11' x 3'10"	3'5"	1'7"	1'7"

Blade capacities are based on the recommended practice ISO 9246. Use of high-tensile-strength steel in moldboard for strengthened blade construction.

*Optional PAT Dozer Assembly (EX), 11' x 3' 10" (3350 mm x 1170 mm) wide



STANDARD EQUIPMENT FOR BASE MACHINE*

- Accumulator for Electric Proportional Control (EPC)
- Air cleaner, dry, double element type with caution lamp on monitor
- Air conditioner (A/C)
- Air inlet
- Alternator, 24 V/85 A
- Back-up alarm
- Batteries, large capacity 24 V/92 Ah
- Cab accessories
 - 12 V x 2 power supply
 - Cup holder
 - Rear view mirror
 - Rear view monitor system
- Crankcase guard and underguard
- Decelerator/brake pedal (Single pedal)
- Electronically controlled Hydrostatic Transmission (HST) with quick-shift and variable speed settings
- Electronic monitor panel with on-board diagnostics
- Engine hood and side panels
- Engine, KOMATSU SAA4D107E-3, gross output of 98 kW **131 HP**, direct injection, water-cooled turbocharged, air-to-air aftercooler, cooled EGR, EPA Tier 4 Final and EU Stage 4 emissions certified
- Fan, hydraulic driven, electronic control
- Filler cap locks and cover locks
- Foot rest, high mounted
- Fuel pre-filter (10 micron) and fuel filter (2 micron)
- Grease gun holder
- High altitude arrangement (No fuel adjustment up to 2300 m)
- Horn
- Hydraulics for PAT dozer
- Intake pipe with precleaner
- Komatsu Diesel Oxidation Catalyst (KDOC)
- KOMTRAX Level 5.0
- Large high-resolution LCD
- Lunch box holder
- Marks and plates, English
- New Operator Identification System
- Palm Command Control System (PCCS) with electronic control for travel control
- Palm Command Control System (PCCS) with EPC for blade control
- Power turn with counter rotation
- Pullhook, front
- Radiator guard grid
- Radiator reserve tank
- Real-time DEF monitoring
- Rear-hinged radiator guard
- Reverse travel speed presets
- ROPS cab
 - Meets ISO 3471, SAE J/ISO 3471 ROPS standards, and ISO 3449 FOPS standard.
- Seat belt, 76 mm **3"** retractable
- Seat, air suspension, fabric, heated, low back, headrest
- Shovel holder
- Starting motor, 24 V/4.5 kW
- Selective Catalytic Reduction (SCR)
- Self adjusting roller
- Sprockets, bolt-on
- Sprocket inner guard
- Track roller guards, end section
- Track shoe assembly (PLUS)
 - Sealed and lubricated
- D51EX-24: 560 mm **22"** MS single grouser shoe
- D51PX-24: 710 mm **28"** MS single grouser shoe
- Triple labyrinth final drive
- Water separator
- Worklamp (Front 3, rear 2)

Dozer assembly and rear-mounted equipment are not included in base machine price.



OPTIONAL EQUIPMENT

- Dozer assembly
- Hitch
- Hydraulics for rear equipment
- Track roller guard, full length

Multi-shank ripper (for D51EX only)

Weight.....	860 kg	1,874 lb
Beam length.....	1556 mm	5'1"
Maximum lift above ground.....	380 mm	1'3"
Maximum digging depth.....	425 mm	1'8"
Number of shanks.....	3	



ALLIED MANUFACTURER'S ATTACHMENTS (SHIPPED LOOSE)

- Guarding - Komatsu
 - Front sweeps 258 kg **569 lb**
 - Hinged cab side screens 44 kg **97 lb**
 - Hinged cab rear screen 43 kg **95 lb**
 - Rear A/C guard (requires front sweep) 61 kg **134 lb**
- Hydraulic winch - Allied H5C (without wire rope) 953 kg **2,101 lb**



AESS916-03

©2018 Komatsu America Corp.

Printed in USA

AD04(2.5M)OTP

04/18(EV-1)

KOMATSU®

Note: All comparisons and claims of improved performance made herein are made with respect to the prior Komatsu model unless otherwise specifically stated.

www.komatsuamerica.com

Komatsu America Corp. is an authorized licensee of Komatsu Ltd.

Materials and specifications are subject to change without notice

KOMATSU®, Komatsu Care®, KOMTRAX® and KOMTRAX Plus® are registered trademarks of Komatsu Ltd.

All other trademarks and service marks used herein are the property of Komatsu Ltd., Komatsu America Corp. or their respective owners or licensees.

D51EX/PX-24